



AIRLESS LINE MARKING EQUIPMENT

POWER CONTROL ON THE ROAD
PROVEN PERFORMANCE
DEFINED LINES AT THE FIRST PASS



TECHNICAL QUALITY CERTIFIED

WE'RE SPECIALIZED IN AIRLESS TECHNOLOGY

SAMOA professional airless road marking machines joins product performance with operator needs and allow marking and maintenance of all types lines for flooring, highways, airfields, crossings pedestrian, bicycle paths, parking lots, squares and all that is required by the code of the road in the field of horizontal sign age, guaranteeing perfect lines on different types of surfaces.

Airless technology provides high-pressure paint spray through airless nozzle of centimetre size versus traditional spraying allow pressure where the flow of paint is sprayed through the air supply.

ADVANCED MARKING SOLUTIONS

Increase your productivity on the road

AT THE FIRST PASS NET MARKING LINES

With only one "pass" the marking line is defined uniformly: the line of an airless spraying is linear, clear and sharp thanks to the flat cutting airless nozzle and without jagged effects due to the turbulence caused by the air.

OVER SPRAY MINIMIZED

Airless operation marking eliminates the classic "Overspray" particle dispersion of paint typical of traditional air paint. This results is in a paint saver, in the larger one protection for the health of the operator and the environment.

SAVES UP TO 30% OF PAINT

Thanks to the lack of Overspray the almost totality of the product used is applied to the surface without waste.

VIBRATION REDUCTION

Vibration reduction ensures the quality of the lines best in the road marking sector.

THE PAINT DRIES QUICKLY

Airless marking operation requires the use of filtered varnish specific for airless applications, this in itself means homogeneous, smooth and uniform texture that does not will make any crust, nor will it become gelatinous or thick. The paint adheres tensely to all types of flooring, with excellent visibility and wear resistance both from traffic and from atmospheric agents. High quality paints ensure faster speeds drawing, longer line visibility, and a agreeable aesthetic result.

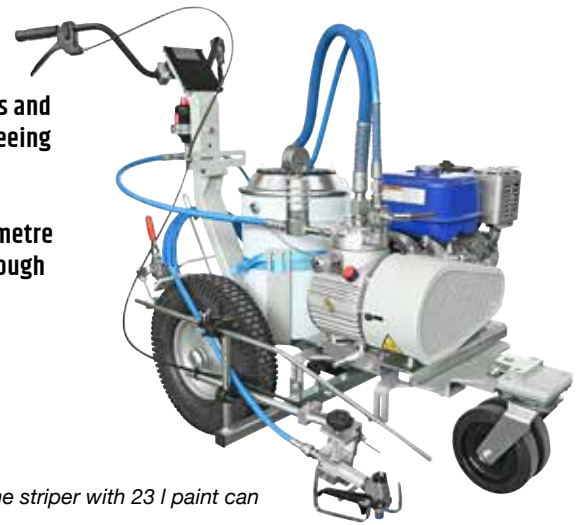

Part No. LA18383
DALI PLUS airless line striper with 23 l paint can

REFLECTIVE BEAD APPLICATION

Reflective beads apply with a gravity dispenser driven by the same command that drives the painting gun. The "spheres" automatically fall on the strip just drawn. Do not use pre-mixed beads.

50 L NO-STICK GRAVITY TANK

Thanks to the large capacity of the hopper the tracing times are prolonged due to the absence of frequent interruptions to effect colour change.

MARKING ROAD SIGNS AND CURVES

Airless paint gun can be released within a few seconds of its support, thanks to the different lengths of airless hose to which it is connected, it allows any work like marking road signs and painting walls. The front wheel facilitates marking lines up to the sidewalk and easy marking of bows and curves.

INTUITIVE USE BY THE OPERATOR

Operator controls are in front of the handlebar to adjust the road marking machines operation with extreme manageability.

EASY OPERATION, CLEANING AND MAINTENANCE

The cleaning of the airless marking machine is fast due to the absence of pressurized tank to be cleaned and therefore change times colour are very short lived. The high pressure of the road marking airless machine does not require therefore a preventive cleaning of the ground. Regular cleaning at work is enough to keep it the machine in perfect efficiency even after long periods of inactivity. SAMOA Super Fast Clean airless nozzles allow cleaning of the nozzle with a simple rotating movement, without have to disassemble it.

AIRLESS ROAD MARKING MACHINES

DIAPHRAGM PUMP

FROM SAMOA PROVEN STRIPING TECHNOLOGY A WIDE RANGE OF ROAD-MARKING AND PAVEMENT MAINTENANCE EQUIPMENT.



GIOTTO
Part No. LA4080
with glass beads kit (optional)

CHOOSE YOUR CONFIGURATION

MODEL	DALÌ PLUS			GIOTTO		
	LA18383	LA18382	LA18382/1	LA4081	LA4080	LA4080/1
PART No.	LA18383	LA18382	LA18382/1	LA4081	LA4080	LA4080/1
PETROL ENGINE POWER	4,8 HP	4,8 HP	4,8 HP	11,7 HP	11,7 HP	11,7 HP
MAX. FLOW RATE	4 l/min	4 l/min	4 l/min	8 l/min	8 l/min	8 l/min
MAX. PRESSURE	220 bar	220 bar	220 bar	220 bar	220 bar	220 bar
MANUAL PUSH	•	•	•	-	-	-
SELF PROPELLED	-	-	-	•	•	•
HEAD CONTROL SYSTEM	-	-	-	-	-	•
AUTOMATIC MARKING LINES KIT	-	-	-	-	-	•
GLASS BEADS KIT	-	-	•	-	-	-
FLASHING TELESCOPIC ROD	-	-	-	•	•	•
23 L PAINT CAN	•	-	-	-	-	-
50 L GRAVITY TANK	-	•	•	•	•	•
Ø 1/4" - M16 X 1,5 - 10 M AIRLESS HOSE	•	•	•	•	•	•
RECIRCULATION HOSE	•	•	•	•	•	•
FILTER WITH PRESSURE GAUGE	•	•	•	•	•	•
1 AT250 AIRLESS MANUAL SPRAY GUN	•	•	-	•	-	-
2 AT250 AIRLESS MANUAL SPRAY GUNS	-	-	•	-	•	•
2 LA96 AIRLESS AUTOMATIC SPRAY GUNS	-	-	-	-	-	•
AIRLESS NOZZLE HOLDER	•	•	•	•	•	•
SUPER FAST CLEAN AIRLESS SPRAYING NOZZLES	•	•	•	•	•	•
1 COLOUR	•	•	•	•	•	•
1 SINGLE LINE: CONTINUOUS - DASHED	•	•	•	-	-	-
2 DOUBLE LINES: CONTINUOUS - DASHED - MIXED	-	-	-	•	•	•
TOOLS KIT	•	•	•	•	•	•

AIRLESS ROAD MARKING MACHINES PISTON PUMP

**SAMOA ON THE ROAD.
THE BEST MARKING ON YOUR SIDE**



DRAGON
Part No. LA4595

CHOOSE YOUR CONFIGURATION

MODEL	EXCALIBUR		ZEUS				DRAGON				EVEREST TH
PART No.	LA4861	LA4860	LA4561	LA4560	LA4591	LA4590	LA4595	LA4596	LA4597	LA4598	LA4000
PETROL ENGINE POWER	4,8 HP	4,8 HP	8,4 HP	8,4 HP	8,4 HP	8,4 HP	8,4 HP	8,4 HP	8,4 HP	8,4 HP	11,7 HP
MAX. FLOW RATE	2,2 l/min	2,2 l/min	4,5 l/min	4,5 l/min	4,5 l/min	4,5 l/min	6,5 l/min	6,5 l/min	6,5 l/min	6,5 l/min	9 l/min
MAX. PRESSURE	220 bar	220 bar	220 bar	220 bar	220 bar	220 bar	220 bar	220 bar	220 bar	220 bar	220 bar
MANUAL PUSH	•	•	•	•	•	•	•	•	•	•	-
SELF PROPELLED	-	-	-	-	-	-	-	-	-	-	•
HEAD CONTROL SYSTEM	-	-	-	-	-	-	-	-	-	-	•
AUTOMATIC MARKING LINES KIT	-	-	-	-	-	-	-	-	-	-	•
GLASS BEADS KIT	-	-	-	-	-	-	-	-	-	-	•
FLASHING TELESCOPIC ROD KIT	-	-	-	-	-	-	-	-	-	-	•
WORKING LIGHT KIT	-	-	-	-	-	-	-	-	-	-	•
OPERATOR FOOT BOARD KIT	-	-	-	-	-	-	-	-	-	-	•
PISTON TYPE ACCUMULATOR	•	•	•	•	•	•	•	•	•	•	•
23 L PAINT CAN	•	-	•	-	•	-	•	-	•	-	-
50 L GRAVITY TANK	-	•	-	•	-	•	-	•	-	•	•
Ø 1/4" - M16 X 1,5 - 10 M AIRLESS HOSE	•	•	•	•	•	•	-	-	-	-	-
Ø 1/4" - M16 X 1,5 - 15 M AIRLESS HOSE	-	-	-	-	-	-	•	•	•	•	•
RECIRCULATION HOSE	•	•	•	•	•	•	•	•	•	•	•
FILTER WITH PRESSURE GAUGE	•	•	•	•	•	•	•	•	•	•	•
1 AT250 AIRLESS MANUAL SPRAY GUN	•	•	•	•	-	-	•	•	-	-	•
2 AT250 AIRLESS MANUAL SPRAY GUNS	-	-	-	-	•	•	-	-	•	•	-
2 LA96 AIRLESS AUTOMATIC SPRAY GUNS	-	-	-	-	-	-	-	-	-	-	•
AIRLESS NOZZLE HOLDER	•	•	•	•	•	•	•	•	•	•	•
SUPER FAST CLEAN AIRLESS SPRAYING NOZZLES	•	•	•	•	•	•	•	•	•	•	•
1 COLOUR	•	•	•	•	•	•	•	•	•	•	•
1 SINGLE LINE: CONTINUOUS - DASHED	•	•	•	•	-	-	•	•	-	-	-
2 DOUBLE LINES: CONTINUOUS - DASHED - MIXED	-	-	-	-	•	•	-	-	•	•	•
TOOLS KIT	•	•	•	•	•	•	•	•	•	•	•

AIRLESS BATTERY ROAD MARKING MACHINE PISTON PUMP

**SAMOA EXPERIENCE MAKES THE DIFFERENCE:
PROVEN PERFORMANCE FOR DEFINED LINES**



CHOOSE YOUR CONFIGURATION

MODEL	ECO K21
PART No.	LA4861
ELECTRIC ENGINE	0,75 Kw
BATTERY ENGINE	960 A/h (4 batteries)
MAX. FLOW RATE	2,2 l/min
MAX. PRESSURE	220 bar
SELF-PROPELLED	•
HEAD CONTROL SYSTEM	•
AUTOMATIC MARKING LINES KIT	-
FLASHING TELESCOPIC ROD KIT	•
WORKING LIGHT KIT	-
OPERATOR FOOTBOARD KIT	-
PISTON TYPE ACCUMULATOR	•
50 L GRAVITY TANK	•
Ø 1/4" - M16 X 1,5 - 10 M AIRLESS HOSE	•
RECIRCULATION HOSE	•
FILTER WITH PRESSURE GAUGE	•
1 AT250 AIRLESS MANUAL SPRAY GUN	•
AIRLESS NOZZLE HOLDER	•
SUPER FAST CLEAN AIRLESS SPRAYING NOZZLES	•
1 COLOUR	•
1 SINGLE FILTER LINE PUT: CONTINUOUS - DASHED	•
BATTERY CHARGER	•
TOOLS KIT	•

DALÌ PLUS AIRLESS LINE MARKER

**HIGH PRESSURE - MANUAL PUSH - DIAPHRAGM PUMP
4 L/MIN - 220 BAR - 4,8 HP HONDA PETROL ENGINE**

Ergonomic handle- Reduced vibrations

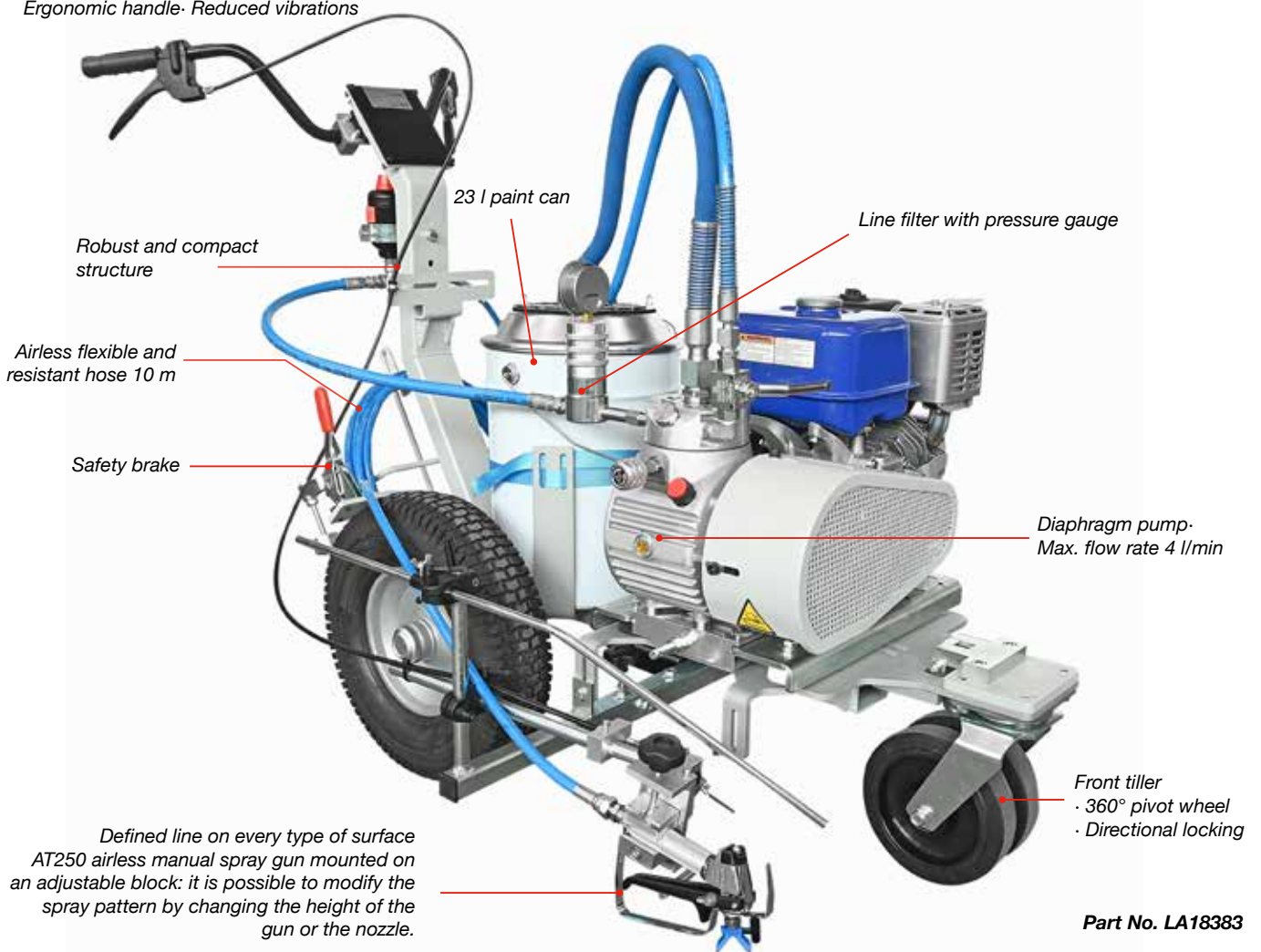

APPLICATIONS

MEDIUM SIZE MARKING - MAINTENANCE - PAINTING JOBS

- Roads - Highways
- Galleries - Road tunnels
- Cycle runway
- Outdoor and underground parking
- Playgrounds
- Sports circuits
- Public and private areas
- Airports

MATERIALS

Water or solvent paint without suspended particles

LINE TYPE

SINGLE LINE

- 1 Colour
- Continuous - Dashed
- Width from 5 to 30 cm



DALÌ PLUS SERIES

TECHNICAL DATA

SERIES	DALÌ PLUS
MODELS	Manual push - Diaphragm pump
MAX. PRESSURE	220 bar
MAX. FLOW RATE	4 l/min
HONDA PETROL ENGINE	4,8 HP
AIRLESS PAINT CAPACITY	23 l paint can - 50 l gravity tank
DIMENSIONS	1.250 x 820 x 1.400 mm
WEIGHT	120 kg



Cod. LA18382
DALÌ PLUS strippar per linee
airless con serbatoio a gravità da 50 l

PART No.	MANUAL PUSH	23 L PAINT CAN	50 L GRAVITY TANK	AUTOMATIC MARKING KIT	AIRLESS HOSE	AT250 AIRLESS MANUAL GUN	AIRLESS NOZZLE HOLDER	SUPER FAST CLEAN AIRLESS NOZZLES
LA18383	•	•	-	-	N°1 Part No. LA35015 Ø 1/4" - M16 x 1,5 - 10 m	N°1 Part No. LA11210 M16 x 1,5 inlet swivel	N°1 Part No. LA18270	N° 1 LASFC 11-40 N° 1 LASFC 13-40 N° 1 LASFC 15-40
LA18382	•	-	•	-	N°1 Part No. LA35015 Ø 1/4" - M16 x 1,5 - 10 m	N°1 Part No. LA11210 M16 x 1,5 inlet swivel	N°1 Part No. LA18270	N° 1 LASFC 11-40 N° 1 LASFC 13-40 N° 1 LASFC 15-40
LA18382/1	•	-	•	•	N°1 Part No. LA35015 Ø 1/4" - M16 x 1,5 - 10 m	N°2 Part No. LA11210 M16 x 1,5 inlet swivel	N°2 Part No. LA18270	N° 2 LASFC 13-40 N° 2 LASFC 15-40 N° 2 LASFC 19-40

DALÌ PLUS series includes:

filter with pressure gauge, recirculation hose and tools box.

ACCESSORIES

PART No.	DESCRIPTION
LA35015	Airless hose Ø 1/4" - M16 x 1,5 inlet swivel - 10 m
LA11200	AT250 manual airless spray gun - M16 x 1,5 inlet swivel + Nozzle holder
LA11210	AT250 manual airless spray gun - M16 x 1,5 inlet swivel
LA18270	11/16" Europe W airless nozzle holder
LASFC	Super Fast Clean airless nozzle. Size from 11-20 to 51-80
LATSC	Top Spraying Clean airless nozzle. Size from 7-10 to 31-60
LA18240	50 l Gravity tank
LA18245	50 l Gravity tank + Cover
LA18241	50 l Gravity tank + Cover+ Basket
LA4500	11 l Gravity tank + Glass beads diffuser hose
LA19510	11 l glass beads gravity tank
LA19510/1	Over 11 l glass beads gravity tank

Part No. LA18382/1

DALÌ PLUS airless lines striper
with glass beads dispenser kit (optional)



KITS

PART No.	DESCRIPTION
LA200270	Complete kit for second airless gun for Part No. LA18383 and Part No. LA18382. (mounting kit Part No. LA4307 + airless gun Part No. LA11200 + airless nozzles Part No. LASFC 11 - 40 / 13 - 40 / 15 - 40)
LA4307	Mounting kit for second airless gun (airless gun not included)
LA18359	11 l Gravity tank + 1 Diffuser hose + 1 Glass beads manual spray gun kit
LA18354	11 l Gravity tank + 2 Diffuser hoses + 2 Glass beads manual spray guns kit
LA4038	Laser pointer kit
LA4840	Gun handling + Front pivot

GIOTTO AIRLESS LINE MARKER

**HIGH PRESSURE - SELF-PROPELLED - DIAPHRAGM PUMP
8 L/MIN - 220 BAR - 11,7 HP HONDA PETROL ENGINE**

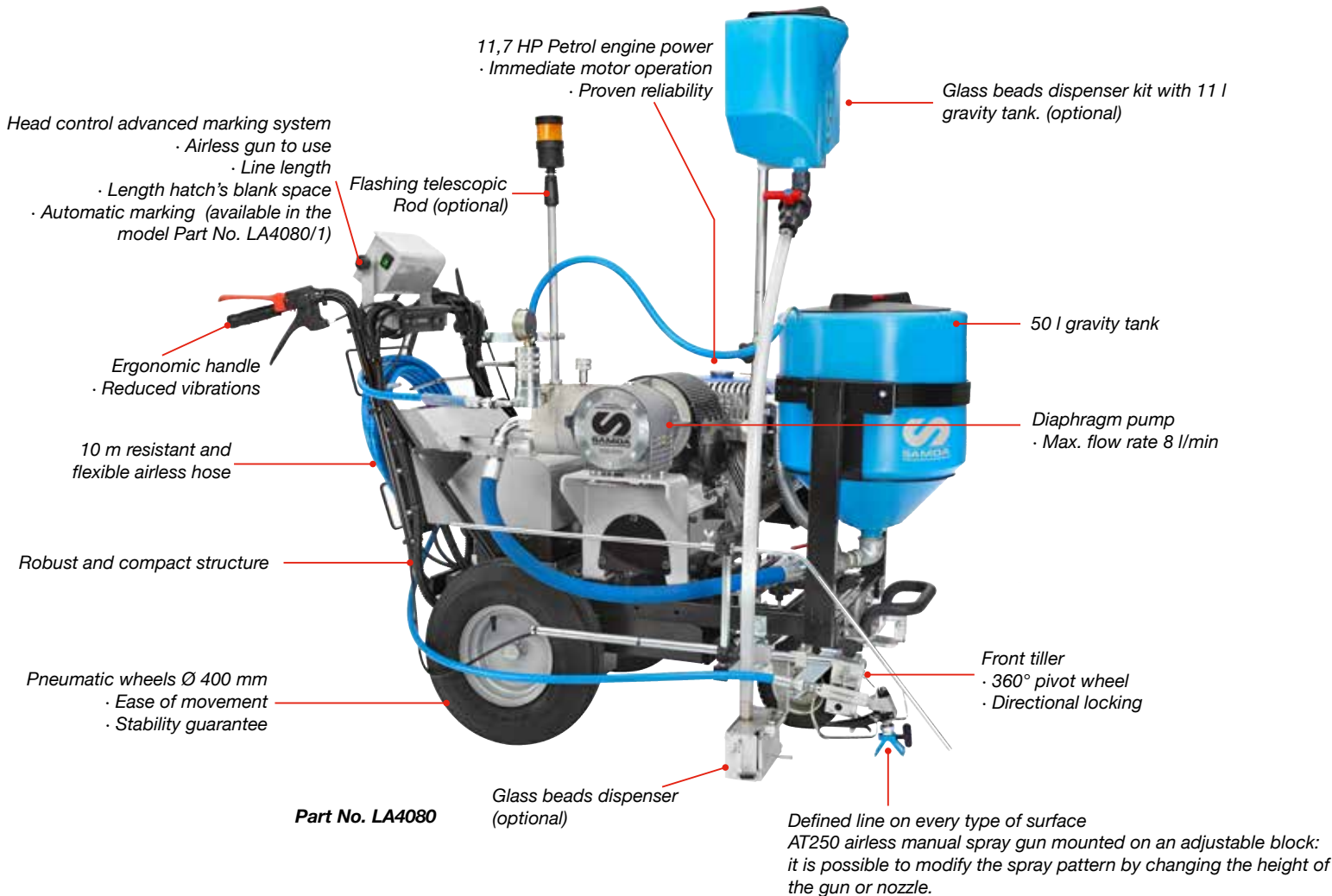

APPLICATIONS

BIG SIZE MARKING - MAINTENANCE - PAINTING JOBS

- Roads - Highways
- Galleries - Road tunnels
- Cycle runway
- Outdoor and underground parking
- Playgrounds
- Sports circuits
- Public and private areas
- Airports

MATERIALS

Water or solvent paint without suspended particles

LINE TYPE

DOUBLE LINE

- 1 Colour
- Continuous - Dashed - Mixed
- Width from 5 to 30 cm



GIOTTO SERIES

TECHNICAL DATA	
SERIES	GIOTTO
MODELS	Self-propelled - Diaphragm pump
MAX. PRESSURE	220 bar
MAX. FLOW RATE	8 l/min
HONDA PETROL ENGINE	11,7 HP
AIRLESS PAINT CAPACITY	50 l gravity tank
DIMENSIONS	1.430 x 1.930 x 1.560 mm
WEIGHT	300 kg

PART No.	SELF PROPELLED	AUTOMATIC MARKING	50 L GRAVITY TANK	AIRLESS HOSE	AT250 AIRLESS MANUAL GUN	LA96 AIRLESS AUTOMATIC GUN	AIRLESS NOZZLE HOLDER	SUPER FAST CLEAN AIRLESS NOZZLES
LA4081	•	-	•	N°1 Part No. LA35015 Ø 1/4" - M16 x 1,5 - 10 m	N°1 Part No. LA11210 M16 x 1,5 inlet swivel	-	N° 1 Part No. LA18270	N° 1 LASFC 11-40 N° 1 LASFC 13-40 N° 1 LASFC 17-40
LA4080	•	-	•	N°1 Part No. LA35015 Ø 1/4" - M16 x 1,5 - 10 m	N°2 Part No. LA11210 M16 x 1,5 inlet swivel	-	N° 2 Part No. LA18270	N° 2 LASFC 11-40 N° 2 LASFC 13-40 N° 2 LASFC 17-40
LA4080/1	•	•	•	N°1 Part No. LA35015 Ø 1/4" - M16 x 1,5 - 10 m	N°2 Part No. LA11210 M16 x 1,5 inlet swivel	N°2 Part No. LA11708 M16 x 1,5 inlet swivel	N° 4 Part No. LA18270	N° 2 LASFC 11-40 N° 2 LASFC 13-40 N° 2 LASFC 17-40 N° 2 LASFC 19-40

GIOTTO series includes:

filter with pressure gauge, recirculation hose, flashing telescopic rod and tools box.

ACCESSORIES

PART No.	DESCRIPTION
LA35015	Ø 1/4" - M16 x 1,5 inlet swivel - 10 m Airless hose
LA11200	AT250 manual airless spray gun - M16 x 1,5 inlet swivel + Nozzle holder
LA11210	AT250 manual airless spray gun - M16 x 1,5 inlet swivel
LA18270	11/16" Europe W airless nozzle holder
LASFC	Super Fast Clean airless nozzle. Size from 11-20 to 51-80
LATSC	Top Spraying Clean airless nozzle. Size from 7-10 to 31-60
LA18240	50 l Gravity tank
LA18245	50 l Gravity tank + Cover
LA18241	50 l Gravity tank + Cover+ Basket
LA4500	11 l Gravity tank + Glass beads diffuser hose
LA26000	Operator footboard
LA4720	Seat kit
LA19510	11 l glass beads gravity tank
LA19510/1	Cover 11 l glass beads gravity tank

KITS

PART No.	DESCRIPTION
LA18359	11 l Gravity tank + 1 Diffuser hose + 1 Glass beads manual spray gun kit
LA18354	11 l Gravity tank + 2 Diffuser hoses + 2 Glass beads manual spray guns kit
LA4405/3	11 l Gravity tank + 2 Diffuser hoses + 2 Glass beads automatic spray guns kit

EXCALIBUR AIRLESS LINE MARKER

HIGH PRESSURE - MANUAL PUSH - PISTON PUMP
2,2 L/MIN - 220 BAR - 4,8 HP HONDA PETROL ENGINE

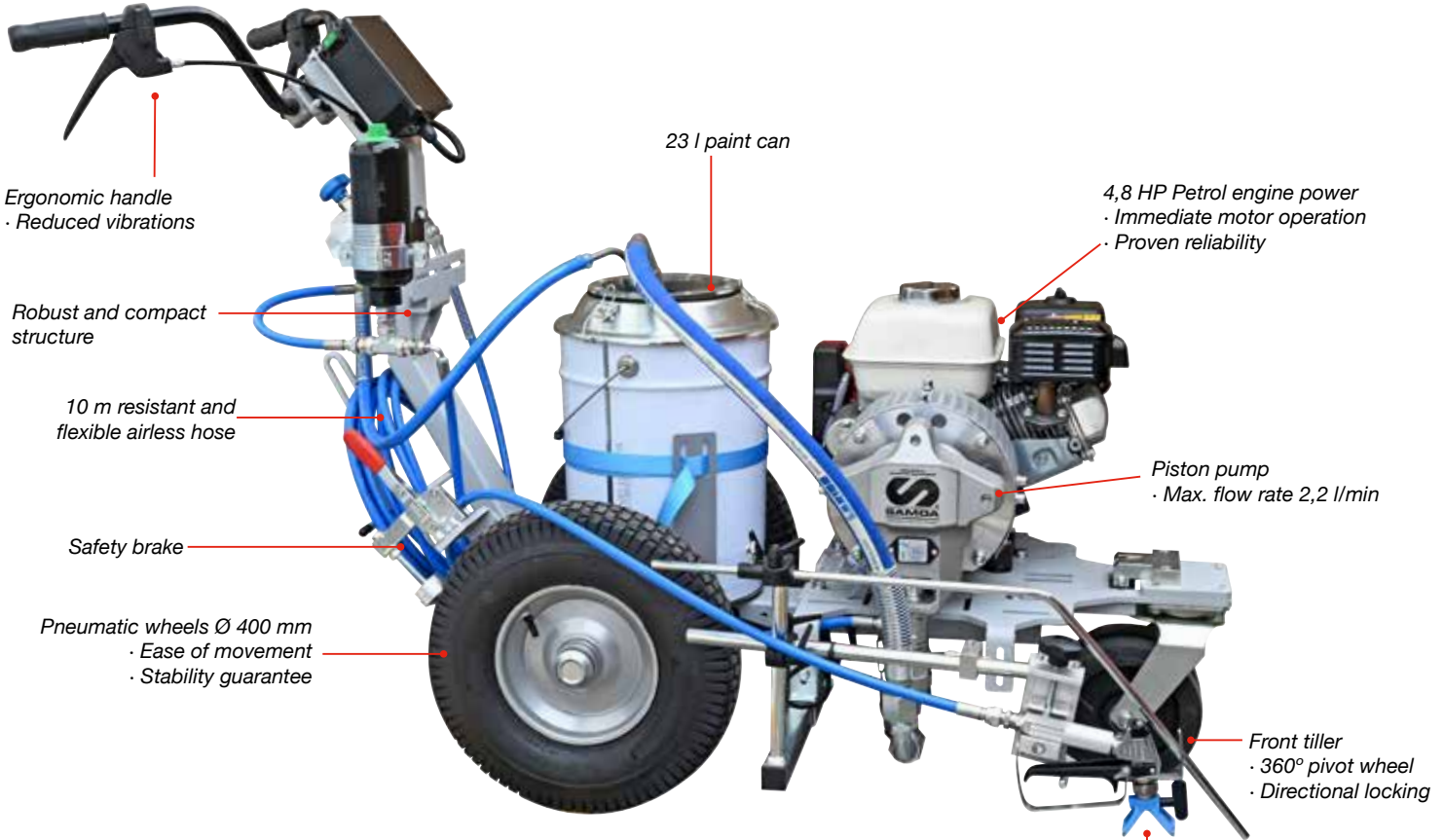

Ergonomic handle
 · Reduced vibrations

Robust and compact structure

10 m resistant and flexible airless hose

Safety brake

Pneumatic wheels Ø 400 mm
 · Ease of movement
 · Stability guarantee

23 l paint can

4,8 HP Petrol engine power
 · Immediate motor operation
 · Proven reliability

Piston pump
 · Max. flow rate 2,2 l/min

Front tiller
 · 360° pivot wheel
 · Directional locking

Part No. LA4861

Defined line on every type of surface
 AT250 airless manual spray gun mounted on an adjustable block: it is possible to modify the spray pattern by changing the height of the gun or nozzle.

APPLICATIONS

MEDIUM SIZE MARKING - MAINTENANCE - PAINTING JOBS

- Roads - Highways
- Galleries - Road tunnels
- Cycle runway
- Outdoor and underground parking
- Sports circuits
- Public and private areas
- Airports

MATERIALS

Water or solvent paint without suspended particles

LINE TYPE

SINGLE LINE

- 1 Colour
- Continuous - Dashed
- Width from 5 to 30 cm



EXCALIBUR SERIES

Part No. LA4860
EXCALIBUR airless lines striper
with 50 l gravity tank

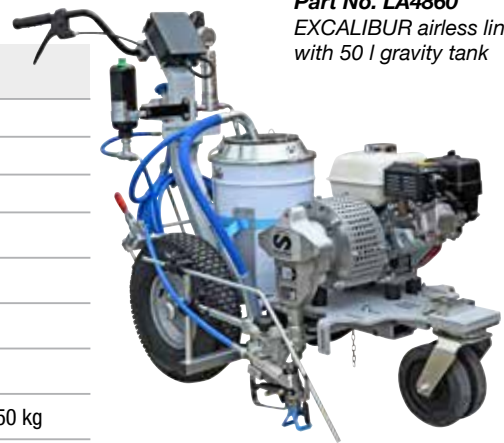

TECHNICAL DATA	
SERIES	EXCALIBUR
MODELS	Manual push - Piston pump
MAX. PRESSURE	220 bar
MAX. FLOW RATE	2,2 l/min
HONDA PETROL ENGINE	4,8 HP
AIRLESS PAINT CAPACITY	23 l paint can - 50 l gravity tank
DIMENSIONS	1.400 x 820 x 1.250 mm
WEIGHT	Part No. LA4861, 108 kg - Part No. LA4860, 150 kg

PART No.	MANUAL PUSH	23 L PAINT CAN	50 L GRAVITY TANK	AIRLESS HOSE	AT250 AIRLESS MANUAL GUN	AIRLESS NOZZLE HOLDER	SUPER FAST CLEAN AIRLESS NOZZLES
LA4861	•	•	-	N°1 Part No. LA35015 Ø 1/4" - M16 x 1,5 - 10 m	N°1 Part No. LA11210 M16 x 1,5 inlet swivel	N°1 Part No. LA18270	N° 1 LASFC 11-40 N° 1 LASFC 13-40 N° 1 LASFC 15-40
LA4860	•	-	•	N°1 Part No. LA35015 Ø 1/4" - M16 x 1,5 - 10 m	N°1 Part No. LA11210 M16 x 1,5 inlet swivel	N°1 Part No. LA18270	N° 1 LASFC 11-40 N° 1 LASFC 13-40 N° 1 LASFC 15-40

EXCALIBUR series includes:

filter with pressure gauge, recirculation hose and tools box.

ACCESSORIES

PART No.	DESCRIPTION
LA35015	Ø 1/4" - M16 x 1,5 inlet swivel - 10 m Airless hose
LA11200	AT250 manual airless spray gun - M16 x 1,5 inlet swivel + Nozzle holder
LA11210	AT250 manual airless spray gun - M16 x 1,5 inlet swivel
LA18270	11/16" Europe W airless nozzle holder
LASFC	Super Fast Clean airless nozzle. Size from 11-20 to 51-80
LATSC	Top Spraying Clean airless nozzle. Size from 7-10 to 31-60
LA18240	50 l Gravity tank
LA18245	50 l Gravity tank + Cover
LA18241	50 l Gravity tank + Cover+ Basket
LA4500	11 l Gravity tank + Glass beads diffuser hose
LA19510	11 l glass beads gravity tank
LA19510/1	Cover 11 l glass beads gravity tank

KITS

PART No.	DESCRIPTION
LA200271	Complete kit for second airless gun for Part No. LA4861 and Part No. LA4860. (mounting kit Part No. LA4307/1 + airless gun Part No. LA11200 + airless nozzles Part No. LASFC 11-40 / 13-40 /15-40)
LA4307/1	Mounting kit for second airless gun (airless gun not included)
LA18359	11 l Gravity tank + 1 Diffuser hose + 1 Glass beads manual spray gun kit
LA18354	11 l Gravity tank + 2 Diffuser hoses + 2 Glass beads manual spray guns kit
LA4038	Laser pointer kit
LA4840	Gun handling + Front pivot

ZEUS AIRLESS LINE MARKER

HIGH PRESSURE - MANUAL PUSH - PISTON PUMP
4,5 L/MIN - 220 BAR - 8,4 HP HONDA PETROL ENGINE

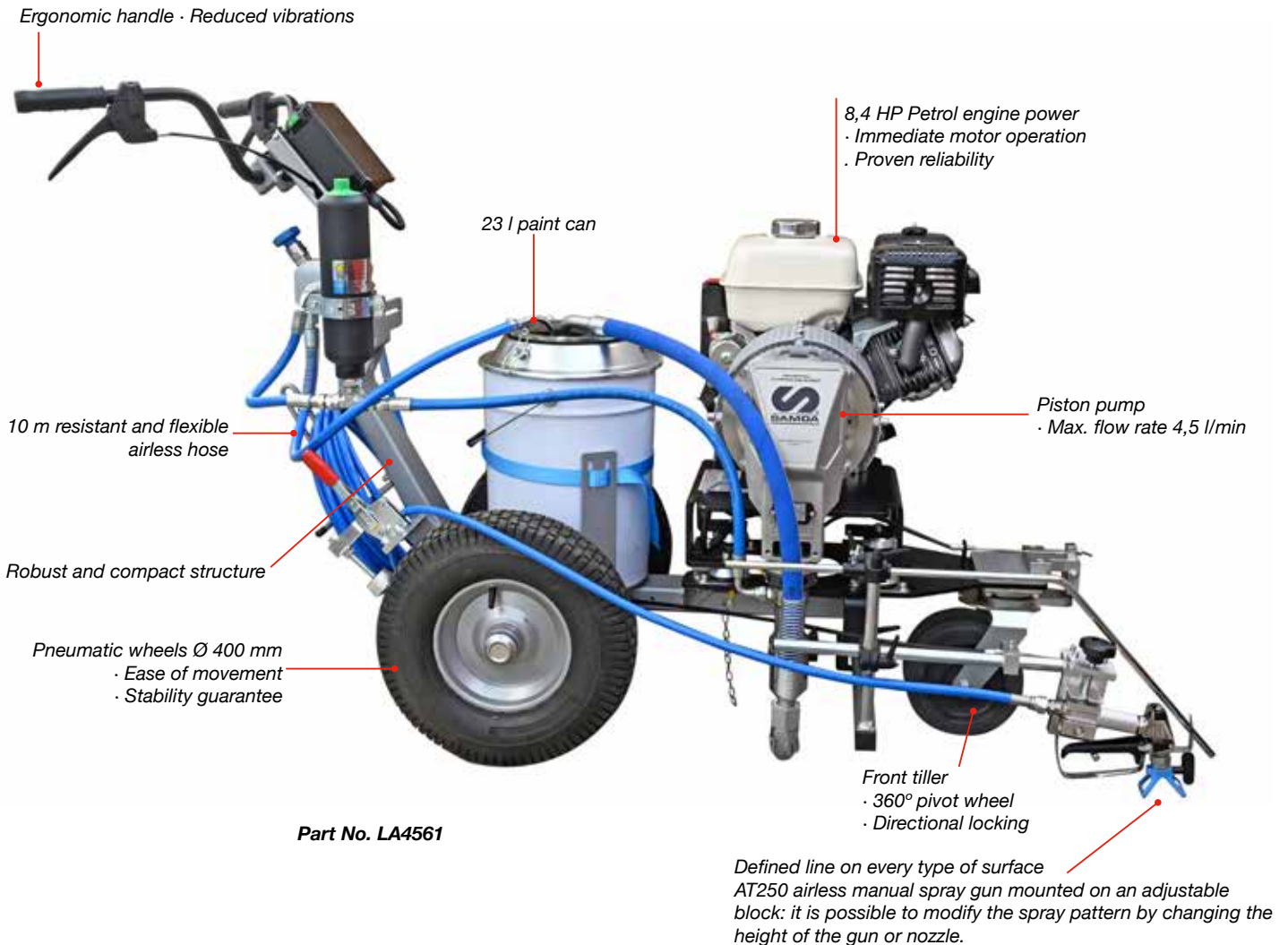

APPLICATIONS

MEDIUM SIZE MARKING - MAINTENANCE - PAINTING JOBS

- Roads - Highways
- Galleries - Road tunnels
- Cycle runway
- Outdoor and underground parking
- Sports circuits
- Public and private areas
- Airports

MATERIALS

Water or solvent paint without suspended particles

LINE TYPE

SINGLE LINE

- 1 Colour
- Continuous - Dashed
- Width from 5 to 30 cm



ZEUS SERIES



Part No. LA4560
ZEUS airless line strippers with 23 l paint can

TECHNICAL DATA	
SERIES	ZEUS
MODELS	Manual push - Piston pump
MAX. PRESSURE	220 bar
MAX. FLOW RATE	4,5 l/min
HONDA PETROL ENGINE	8,4 HP
AIRLESS PAINT CAPACITY	23 l paint can - 50 l gravity tank
DIMENSIONS	1.105 x 1.700 x 850 mm
WEIGHT	150 kg

PART No.	MANUAL PUSH	23 L PAINT CAN	50 L GRAVITY TANK	AIRLESS HOSE	AT250 AIRLESS MANUAL GUN	AIRLESS NOZZLE HOLDER	SUPER FAST CLEAN AIRLESS NOZZLES
LA4561	•	•	-	N°1 Part No. LA35015 Ø 1/4" - M16 x 1,5 - 10 m	N°1 Part No. LA11210 M16 x 1,5 inlet swivel	N°1 Part No. LA18270	N° 1 LASFC 11-40 N° 1 LASFC 13-40 N° 1 LASFC 15-40
LA4560	•	-	•	N°1 Part No. LA35015 Ø 1/4" - M16 x 1,5 - 10 m	N°1 Part No. LA11210 M16 x 1,5 inlet swivel	N°1 Part No. LA18270	N° 1 LASFC 11-40 N° 1 LASFC 13-40 N° 1 LASFC 15-40
LA4591	•	•	-	N°1 Part No. LA35015 Ø 1/4" - M16 x 1,5 - 10 m	N° 2 Part. No LA11210 M16 x 1,5 inlet swivel	N° 2 Part No. LA18270	N° 2 LASFC 11-40 N° 2 LASFC 13-40 N° 2 LASFC 15-40
LA4590	•	-	•	N°1 Part No. LA35015 Ø 1/4" - M16 x 1,5 - 10 m	N° 2 Part. No LA11210 M16 x 1,5 inlet swivel	N° 2 Part No. LA18270	N° 2 LASFC 11-40

ZEUS series includes:

filter with pressure gauge, recirculation hose and tools box.

ACCESSORIES

PART No.	DESCRIPTION
LA35015	Ø 1/4" - M16 x 1,5 inlet swivel - 10 m Airless hose
LA11200	AT250 manual airless spray gun - M16 x 1,5 inlet swivel + Nozzle holder
LA11210	AT250 manual airless spray gun - M16 x 1,5 inlet swivel
LA18270	11/16" Europe W airless nozzle holder
LASFC	Super Fast Clean airless nozzle. Size from 11-20 to 51-80
LATSC	Top Spraying Clean airless nozzle. Size from 7-10 to 31-60
LA18240	50 l Gravity tank
LA18245	50 l Gravity tank + Cover
LA18241	50 l Gravity tank + Cover+ Basket
LA4500	11 l Gravity tank + Glass beads diffuser hose
LA19510	11 l glass beads gravity tank
LA19510/1	Cover 11 l glass beads gravity tank

KITS

PART No.	DESCRIPTION
LA200271	Complete kit for second airless gun for Part No. LA4561 and Part No. LA4560. (mounting kit Part No. LA4307/1 + airless gun Part No. LA11200 + airless nozzles Part No. LASFC 11- 40 / 13 - 40 / 15 - 40)
LA4307/1	Mounting kit for second airless gun (airless gun not included)
LA18359	11 l Gravity tank + 1 Diffuser hose + 1 Glass beads manual spray gun kit
LA18354	11 l Gravity tank + 2 Diffuser hoses + 2 Glass beads manual spray guns kit
LA4038	Laser pointer kit
LA4840	Gun handling + Front pivot

DRAGON AIRLESS LINE MARKER

HIGH PRESSURE - MANUAL PUSH - PISTON PUMP
6,5 L/MIN - 220 BAR - 8,4 HP HONDA PETROL ENGINE

Ergonomic handle · Reduced vibrations

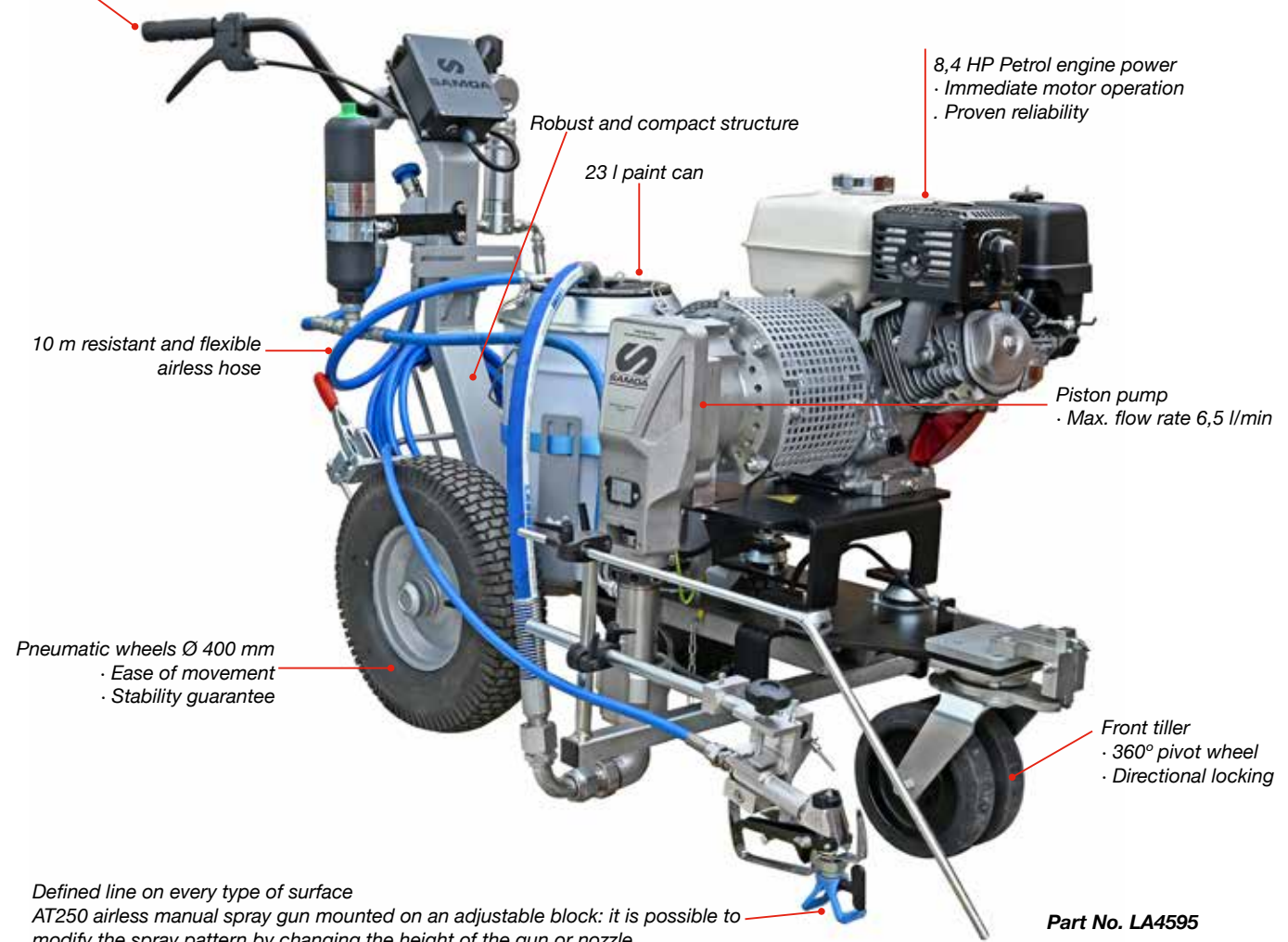

Robust and compact structure

23 l paint can

8,4 HP Petrol engine power
 · Immediate motor operation
 · Proven reliability

10 m resistant and flexible
 airless hose

Piston pump
 · Max. flow rate 6,5 l/min

Pneumatic wheels Ø 400 mm
 · Ease of movement
 · Stability guarantee

Front tiller
 · 360° pivot wheel
 · Directional locking

Defined line on every type of surface
 AT250 airless manual spray gun mounted on an adjustable block: it is possible to modify the spray pattern by changing the height of the gun or nozzle.

Part No. LA4595

APPLICATIONS

BIG SIZE MARKING - MAINTENANCE - PAINTING JOBS

- Roads - Highways
- Galleries - Road tunnels
- Cycle runway
- Outdoor and underground parking
- Sports circuits
- Public and private areas
- Airports

MATERIALS

Water or solvent paint without suspended particles

LINE TYPE

DOUBLE LINE

- 1 Colour
- Continuous - Dashed - Mixed
- Width from 5 to 30 cm



DRAGON SERIES

TECHNICAL DATA

SERIES	DRAGON
MODELS	Manual push - Piston pump
MAX. PRESSURE	220 bar
MAX. FLOW RATE	6,5 l/min
HONDA PETROL ENGINE	8,4 HP
AIRLESS PAINT CAPACITY	23 l paint can - 50 l gravity tank
DIMENSIONS	1.430 x 1.930 x 1.560 mm
WEIGHT	Part No. LA4595, 230 kg - Part No. LA4596, 300 kg

PART No.	MANUAL PUSH	23 L PAINT CAN	50 L TANK	AIRLESS HOSE	AT250 MANUAL AIRLESS GUN	AIRLESS NOZZLE HOLDER	SUPER FAST CLEAN AIRLESS NOZZLES
LA4595	•	•	-	N°1 Part No. LA18026 Ø 1/4" - M16 x 1,5 - 15 m	N°1 Part No. LA11210 M16 x 1,5 inlet swivel	N°1 Part No. LA18270	N°1 LASFC 13-40 N°1 LASFC 17-40 N°1 LASFC 21-40
LA4596	•	-	•	N°1 Part No. LA18026 Ø 1/4" - M16 x 1,5 - 15 m"	N°1 Part No. LA11210 M16 x 1,5 inlet swivel	N°1 Part No. LA18270	N°1 LASFC 13-40 N°1 LASFC 17-40 N°1 LASFC 21-40
LA4597	•	•	-	N°1 Part No. LA18026 Ø 1/4" - M16 x 1,5 - 15 m	N°2 Part No. LA11210 M16 x 1,5 inlet swivel	N°2 Part No. LA18270	N°2 LASFC 13-40 N°2 LASFC 17-40 N°2 LASFC 21-40
LA4598	•	-	•	N°1 Part No. LA18026 Ø 1/4" - M16 x 1,5 - 15 m	N°2 Part No. LA11210 M16 x 1,5 inlet swivel	N°2 Part No. LA18270	N°2 LASFC 13-40 N°2 LASFC 17-40 N°2 LASFC 21-40

DRAGON series includes: filter with pressure gauge, recirculation hose, tools box.

ACCESSORIES

PART No.	DESCRIPTION
LA18026	Ø 1/4" - M16 x 1,5 inlet swivel - 15 m Airless hose
LA11200	AT250 manual airless spray gun - M16 x 1,5 inlet swivel + Nozzle holder
LA11210	AT250 manual airless spray gun - M16 x 1,5 inlet swivel
LA18270	11/16" Europe W airless nozzle holder
LASFC	Super Fast Clean airless nozzle. Size from 11-20 to 51-80
LATSC	Top Spraying Clean airless nozzle. Size from 7-10 to 31-60
LA18240	50 l Gravity tank
LA18245	50 l Gravity tank + Cover
LA18241	50 l Gravity tank + Cover + Basket
LA4500	11 l Gravity tank + Glass beads diffuser hose
LA26000	Operator footboard
LA4720	Seat kit
LA19510	11 l glass beads gravity tank
LA19510/1	Cover 11 l glass beads gravity tank

KITS

PART No.	DESCRIPTION
LA18359	11 l Gravity tank + 1 Diffuser hose + 1 Glass beads manual spray gun kit
LA18354	11 l Gravity tank + 2 Diffuser hoses + 2 Glass beads manual spray guns kit
LA4405/3	11 l Gravity tank + 2 Diffuser hoses + 2 Glass beads automatic spray guns kit
LA4038	Laser pointer kit
LA4506	Working light kit
LA4507	Flashing telescopic rod kit
LA4839	Pneumatic gun handling + Front pivot

EVEREST TH AIRLESS LINE MARKER

**HIGH PRESSURE - SELF PROPELLED - AUTOMATIC MARKING - PISTON PUMP
9 L /MIN - 220 BAR - 11,7 HP HONDA PETROL ENGINE**

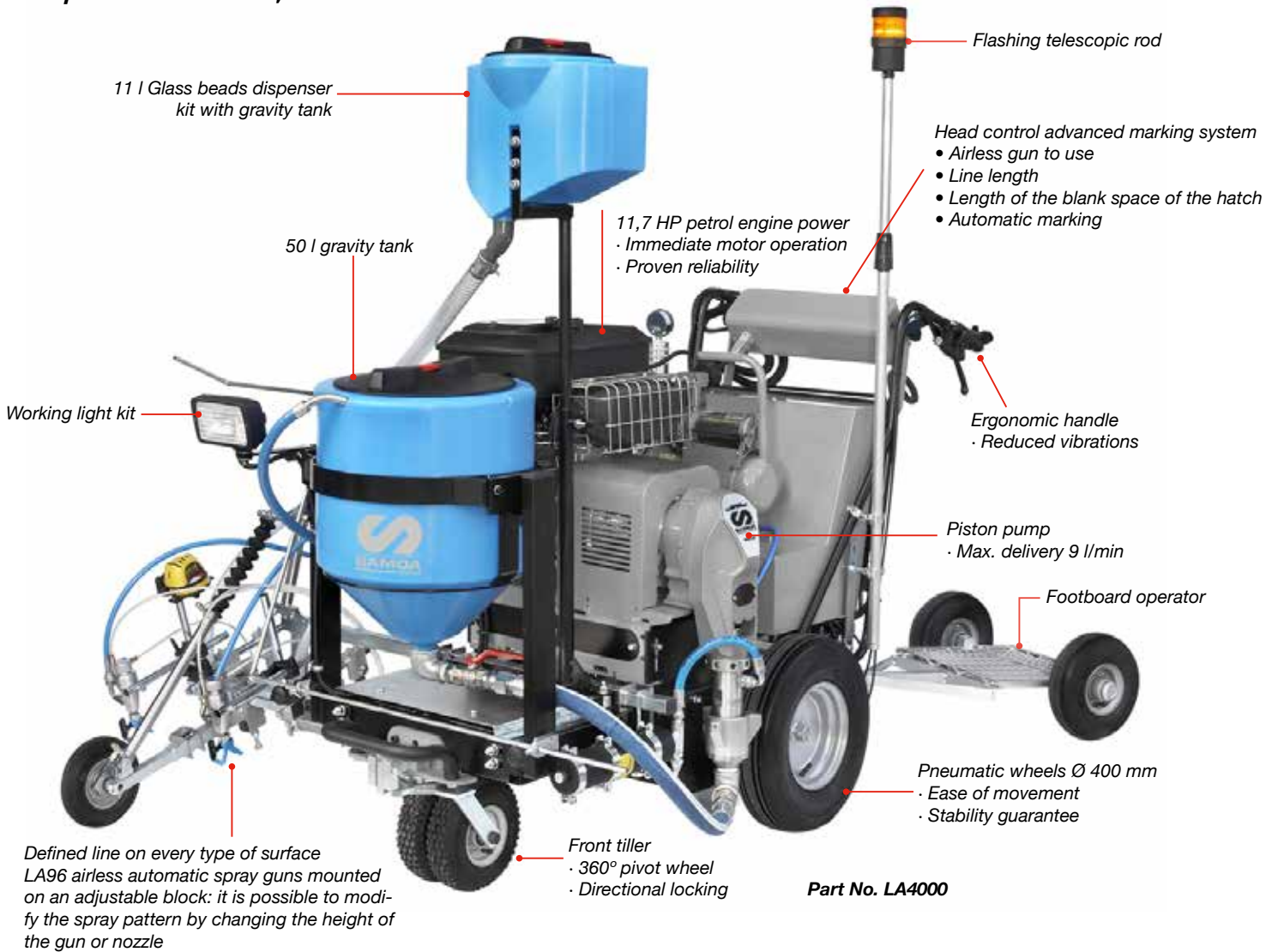

APPLICATIONS

BIG SIZE MARKING - MAINTENANCE - PAINTING JOBS

- Roads - Highways
- Galleries - Road tunnels
- Cycle runway
- Outdoor and underground parking
- Sports circuits
- Public and private areas
- Airports

MATERIALS

Water or solvent paint without suspended particles

LINE TYPE

DOUBLE LINE

- 1 Colour
- Continuous - Dashed - Mixed
- Width from 5 to 30 cm



EVEREST TH SERIES

TECHNICAL DATA

SERIES	EVEREST TH
MODELS	Self-propelled - Piston pump
MAX. PRESSURE	220 bar
MAX. FLOW RATE	9 l/min
HONDA PETROL ENGINE	11,7 HP
AIRLESS PAINT CAPACITY	50 l gravity tank (100 l on request)
DIMENSIONS	1.920 x 1.450 x 1.580 mm
WEIGHT	350 kg

PART No.	SELF PROPELLED	50 L GRAVITY TANK	AUTO-MATIC MARKING	AIRLESS HOSE	AT250 MANUAL AIRLESS GUN	LA96 AUTOMATIC AIRLESS GUN	AIRLESS NOZZLE HOLDER	SUPER FAST CLEAN AIRLESS NOZZLES
LA4000	•	•	•	N°1 Part No. LA18026 Ø 1/4" - M16x1,5 - 15 m	N°1 Part No. LA11210 M16x1,5 inlet swivel	N°2 Part No. LA11708 M16x1,5 inlet swivel	N°3 Part No. LA18270	N°2 LASFC 13-40 N°2 LASFC 17-40 N°2 LASFC 21-40

EVEREST TH series includes:

filter with pressure gauge, recirculation hose, working light, flashing telescopic rod, footboard kit, piston accumulator, gun handling + front pivot and tools box.

ACCESSORIES

PART No.	DESCRIPTION
LA18026	Ø 1/4" - M16 x 1,5 inlet swivel - 15 m Airless hose
LA11200	AT250 manual airless spray gun - M16 x 1,5 inlet swivel + Nozzle holder
LA11210	AT250 manual airless spray gun - M16 x 1,5 inlet swivel
LA11701	LA96 automatic airless spray gun - M16 x 1,5 inlet swivel + Nozzle holder
LA11708	LA96 automatic airless spray gun - M16 x 1,5 inlet swivel
LA18270	11/16" Europe W airless nozzle holder
LASFC	Super Fast Clean airless nozzle. Size from 11-20 to 51-80
LATSC	Top Spraying Clean airless nozzle. Size from 7-10 to 31-60
LA18240	50 l Gravity tank
LA18245	50 l Gravity tank + Cover
LA18241	50 l Gravity tank + Cover + Basket
LA4500	11 l Gravity tank + Glass beads diffuser hose
LA26000	Operator footboard
LA4720	Seat kit
LA4756	Piston accumulator
LA19510	Serbatoio a gravità 11 l per sfere di vetro riflettenti
LA19510/1	Coperchio serbatoio a gravità 11 l per sfere di vetro riflettenti

KITS

PART No.	DESCRIPTION
LA4307	Mounting kit for second airless gun (airless gun not included)
LA18359	11 l Gravity tank+ 1 Diffuser hose + 1 Glass beads manual spray gun kit
LA18354	11 l Gravity tank + 2 Diffuser hoses + 2 glass beads manual spray guns kit
LA4405/3	11 l Gravity tank + 2 Diffuser hoses + 2 Glass beads automatic spray guns kit
LA4506	Working light kit
LA4038	Laser pointer kit
LA4507	Flashing telescopic rod kit
LA4839	Pneumatic gun handling + Front pivot wheel

ECO K21 AIRLESS LINE MARKER

HIGH PRESSURE - SELF PROPELLED - PISTON PUMP
2,2 L/MIN - 220 BAR - 0,75 KW BATTERY POWER



APPLICATIONS

MEDIUM SIZE MARKING - MAINTENANCE - PAINTING JOBS

- Internal logistic marking in all areas where line strippers with petrol engine motor are off-limits
- Roads - Highways
- Galleries - Road tunnels
- Cycle runway
- Outdoor and underground parking
- Sports circuits
- Public and private areas
- Airports

MATERIALS

Water or solvent paint without suspended particles

LINE TYPE

DOUBLE LINE

- 1 Colour
- Continuous - Dashed
- Width from 5 to 30 cm



ECO K21 SERIES

TECHNICAL DATA

SERIES	ECO K21
MODEL	Battery
MAX. PRESSURE	220 bar
MAX. FLOW RATE	2,2 l/m
MOTOR ELECTRIC POWER	0,75 kw
BATTERY ENGINE	960 A/h (4 batteries)
AIRLESS PAINT CAPACITY	50 l gravity tank
DIMENSIONS	1.920 x 1.450 x 1.580 mm
WEIGHT	280 kg

PART No.	BATTERY	SELF PROPELLED	50 L GRAVITY TANK	AIRLESS HOSE	AT250 MANUAL AIRLESS GUN	AIRLESS NOZZLE HOLDER	SUPER FAST CLEAN AIRLESS NOZZLES
LA4200	•	•	•	N°1 Part No. LA35015 Ø 1/4" - M16 x 1,5 - 10 m	N°1 Part No. LA11210 M16 x 1,5 inlet swivel	N°1 Part No. LA18270	N°1 LASFC 11-40 N°1 LASFC 13-40 N°1 LASFC 17-40

ECO K21 series includes:

filter with pressure gauge, recirculation hose, flashing telescopic rod kit, battery charger and tools box.

ACCESSORIES

PART No.	DESCRIPTION
LA18026	Airless hose Ø 1/4" - M16 x 1,5 inlet swivel - 15 m
LA11200	AT250 manual airless spray gun - M16 x 1,5 inlet swivel + Nozzle holder
LA11210	AT250 manual airless spray gun - M16 x 1,5 inlet swivel
LA11701	LA96 automatic airless spray gun - M16 x 1,5 inlet swivel + Nozzle holder
LA18270	Europe 11/16" W airless nozzle holder
LASFC	Super Fast Clean airless nozzle. Size from 11-20 to 51-80
LATSC	Top Spraying Clean airless nozzle. Size from 7-10 to 31-60
LA18240	50 l Gravity tank
LA18245	50 l Gravity tank + Cover
LA18241	50 l Gravity tank + Cover + Basket
LA4500	11 l Gravity tank + Glass beads diffuser hose
LA26000	Operator footboard
LA4720	Seat kit
LA4605	Battery charger
LA19510	11 l glass beads gravity tank
LA19510/1	Cover 11 l glass beads gravity tank

KITS

PART No.	DESCRIPTION
LA200272	Complete kit for second airless gun (mounting kit Part No. LA4307/1 + airless gun Part No. LA11200 + airless nozzles Part No. LASFC 11-40 / 13-40 /17-40)
LA4307/1	Mounting kit for second airless gun (airless gun not included)
LA18359	11 l Gravity tank + 1 Diffuser hose + 1 Glass beads manual spray gun
LA18354	11 l Gravity tank + 2 Diffuser hoses + 2 Glass beads manual spray guns
LA4038	Laser pointer kit
LA4506	Working light kit
LA4507	Flashing telescopic rod kit

ORIGINAL ACCESSORIES FOR HIGH PERFORMANCE

AIRLESS SPRAY GUNS. CONSTANT FLOW FOR DEFINED LINES

AT250 SERIES. MANUAL AIRLESS SPRAY FINISHING GUNS
SUPERIOR ATOMIZATION, FAST APPLICATION, SAVE MATERIAL.

- ALUMINIUM GUN BODY AND ERGONOMIC HANDLE
- HIGH TRANSFER EFFICIENCY
- REDUCED OVERSPRAY PRODUCTION
- LONG CYCLE OF USE



PART No.	DESCRIPTION
LA11200	AT250 manual airless gun - M16 x 1,5 inlet swivel + Nozzle holder
LA11210	AT250 manual airless gun - M16 x 1,5 inlet swivel



Part No. LA11200

TECHNICAL DATA

ACTIVATION	MANUAL
MAX. FLUID PRESSURE	250 bar
MAX. FLUID TEMPERATURE	50 °C
FLUID INLET	M16 x 1,5
WEIGHT	650 g

MATERIALS IN CONTACT WITH FLUID

Aluminium - Stainless Steel - Galvanized steel - Hard metal - PTFE - Brass

SPRAY AIRLESS GUN BUTT FILTERS

PART No.	DESCRIPTION	COLOUR	MESH	QUANTITY
LA11039/25	Butt filter	Green	30	25
LA11038/25	Butt filter	White	60	25
LA11037/25	Butt filter	Yellow	100	25
LA11019/25	Butt filter	Red	200	25



Part No. LA11039/25

Part No. LA11037/25

Part No. LA11019/25

Part No. LA11038/25

LA96 SERIES. AUTOMATIC AIRLESS SPRAY FINISHING GUNS

SUPERIOR ATOMIZATION, FAST APPLICATION, SAVE MATERIAL.

- COMPACT AND ROBUST GUN BODY DESIGN TO INTEGRATE IN ALL WORKING AREAS
- HIGH TRANSFER EFFICIENCY
- REDUCED OVERSPRAY
- LONG CYCLE OF USE



PART No.	DESCRIPTION
LA11701	LA96 automatic airless gun - M16 x 1,5 inlet swivel + Nozzle holder
LA11708	LA96 automatic airless gun - M16 x 1,5 inlet swivel



Part No. LA11701

TECHNICAL DATA

ACTIVATION	AUTOMATIC
MAX. FLUID PRESSURE	300 bar
OPENING AIR PRESSURE RANGE	2 - 6 bar
MAX. FLUID TEMPERATURE	90 °C
AIR INLET	Ø 6 mm
FLUID INLET	M16 x 1,5
WEIGHT	754 g

MATERIALS IN CONTACT WITH FLUID

Stainless Steel - Hard metal - PTFE

PERFORMING AIRLESS SPRAYING NOZZLES & HIGH PRESSURE HOSES

AIRLESS NOZZLE HOLDER

PART No.	DESCRIPTION
LA18270	11/16" W Europe airless nozzle holder



Part No. LA18270

AIRLESS SPRAYING NOZZLES

Homogeneous coverage: the optimized design of the paint nozzle makes the product flow more efficient.

- Compatible with a wide range of paint products
- Tungsten carbide structure
- Stainless steel - PTFE gasket
- Quick and easy cleaning



AIRLESS SUPER FAST CLEAN NOZZLES

PART No.	SIZE	l/min 200 bar
LASFC 11	20 - 40	0,55
LASFC 13	20 - 40 - 60	0,80
LASFC 15	20 - 40 - 60	1,10
LASFC 17	20 - 40 - 60	1,41
LASFC 19	10 - 20 - 40 - 60	1,77
LASFC 21	20 - 40 - 60	2,15
LASFC 23	20 - 40 - 60	2,57
LASFC 25	20 - 40 - 60	2,90
LASFC 27	20 - 40 - 60 - 80	3,50
LASFC 29	20 - 40 - 60 - 80	4,30
LASFC 31	40 - 60 - 80	4,83
LASFC 33	40 - 60 - 80	5,50
LASFC 35	40	6,00
LASFC 37	40	6,70
LASFC 39	40 - 60 - 80	7,10
LASFC 41	40	8,10
LASFC 43	40 - 60 - 80	9,67
LASFC 45	60	9,80
LASFC 47	60	10,70
LASFC 51	40 - 60 - 80	12,20

AIRLESS TOP SPRAYING CLEAN NOZZLES

PART No.	SIZE	l/min 200 bar
LATSC 7	10 - 20 - 40	0,26
LATSC 9	20 - 40	0,35
LATSC 11	10 - 20 - 40	0,55
LATSC 13	20 - 40 - 60	0,80
LATSC 15	10 - 20 - 40 - 60	1,10
LATSC 17	20 - 40 - 60	1,41
LATSC 19	20 - 40 - 60	1,77
LATSC 21	10 - 20 - 40 - 60	2,15
LATSC 23	10 - 20 - 40 - 60	2,57
LATSC 27	10 - 20 - 40 - 60	3,50
LATSC 31	10 - 40 - 60	4,83

GET THE RIGHT LINE WIDTH WITH THE RIGHT LASFC AIRLESS SPRAY TIPS

LINE WIDTH	IN	mm	LASFC 13	LASFC 15	LASFC 17	LASFC 19	LASFC 21	LASFC 23	LASFC 25	LASFC 27	LASFC 29	LASFC 31	LASFC 33	LASFC 35	LASFC 39	LASFC 43
	2 - 4	(51 - 102)		13-20	15-20	17-20	19-20	•	•	•	•	•	•	•	•	•
4 - 6	(102 - 152)		•	15-30	17-30	19-30	21-30	23-30	25-30	27-30	29-30	31-30	33-30	35-30	39-30	43-30
4 - 8	(102 - 204)		•	•	17-40	19-40	21-40	23-40	25-40	27-40	29-40	31-40	•	35-40	39-40	43-40
8 - 12	(204 - 305)		•	•	•	•	21-60	23-60	25-60	27-60	29-60	31-60	•	35-60	39-60	43-60
	FLOW RATE (gpm)		.18	.24	.31	.38	.47	.57	.67	.77	.90	1.03	1.17	1.31	1.63	1.98
	FLOW RATE (lpm)		.69	.91	1.17	1.47	1.79	2.15	2.54	2.96	3.42	3.90	4.42	4.98	6.18	7.51

USEFUL AIRLESS LINE MARKING ACCESSORIES

AIRLESS HOSES

PART No.	DESCRIPTION
LA35015	Airless hose Ø 1/4" - M16x1,5 inlet swivel - 10 m
LA18026	Airless hose Ø 1/4" - M16x1,5 inlet swivel - 15 m



Part No. LA35015

GRAVITY TANKS

PART No.	DESCRIPTION
LA18240	50 l Gravity tank
LA18245	50 l Gravity tank + Cover
LA18241	50 l Gravity tank + Cover + Basket
LA18243	100 l Gravity tank
LA4041/2	100 l Gravity tank + Cover
LA4500	11 l Gravity tank + Glass beads diffuser hose



Part No. LA18241

GLASS BEADS DISPENSER KITS

PART No.	DESCRIPTION
LA18359	11 l Gravity tank + 1 Diffuser hose + 1 glass beads manual spray gun
LA18354	11 l Gravity tank + 2 Diffuser hoses + 2 glass beads manual spray guns
LA4405/3	11 l Gravity tank + 2 Diffuser hoses + 2 glass beads automatic spray guns



Part No. LA4405/3

Part No. LA18354

Part No. LA18359

KITS

PART No.	DESCRIPTION
LA4307	Mounting kit for second airless gun (airless gun not included)
LA4038	Laser pointer kit
LA4506	Working light kit
LA4507	Flashing telescopic rod kit
LA4840	Gun handling + Front pivot wheel
LA19510	11 l glass beads gravity tank
LA19510/1	Cover 11 l glass beads gravity tank



Part No. LA26000

OPERATOR FOOTBOARD

PART No.	DESCRIPTION
LA26000	Operator footboard

SEAT KIT

PART No.	DESCRIPTION
LA4720	Seat kit



Part No. LA4720

PISTON ACCUMULATOR

PART No.	DESCRIPTION
LA4756	Piston accumulator

BATTERY CHARGE

PART No.	DESCRIPTION
LA4605	Battery charger



Part No. LA4756



SAMOA INDUSTRIAL, S.A. - HEADQUARTERS

SPAIN AND EXPORT MARKETS

POL. IND. PORCEYO, I-14 - CAMINO DEL FONTÁN, 831
E-33392 GIJÓN (ASTURIAS), SPAIN
TEL.: +34 985 381 488 - FAX: + 34 985 147 213

SAMOA ITALIA - LARIUS

ITALY

VIA ANTONIO STOPPANI, 21
23801 CALOLZIOCORTE (LC) ITALY
Tel.: +39 0341 621152 - Fax: + 39 0341 621242
Web: www.larius.com

SAMOA LTD.

UNITED KINGDOM AND REP. OF IRELAND

ASTURIAS HOUSE - BARRS FOLD ROAD
WINGATES INDUSTRIAL PARK
WESTHOUGHTON, BL5 3XP, UK
TEL.: +44 1942 850600 - FAX: +44 1942 812160

SAMOA S.A.R.L.

FRANCE

P.A.E.I. DU GIESSEN
3, RUE DE BRISCHBACH
67750 SCHERWILLER, FRANCE
TEL.: +33 3 88 82 79 62 - FAX: +33 3 88 82 77 88

SAMOA FLOWTECH GMBH

GERMANY, AUSTRIA, SWITZERLAND, THE NETHERLANDS AND GREECE
AM OBEREICHHOLZ 4
D - 97828 MARKTHEIDENFELD, GERMANY
TEL.: +49 9391 9826 0 - FAX: +49 9391 98 26 50

SAMOA CORPORATION

USA, MEXICO AND CANADA
90 MONTICELLO ROAD
WEAVERVILLE, NC 28787, USA
TEL. +1 (828) 645-2290 - FAX: +1 (828) 658 0840



©Copyright, SAMOA INDUSTRIAL, S.A.

SAMOA Industrial, S.A. is an ISO 9001, ISO 14001 and ISO 45001 certified company.



Contact us today!

Visit: www.samoaindustrial.com for more information.